

SPICE thermal model

BUK7Y22-100E

Symbol	Parameter	Conditions	Min	Typ	Max	Unit
$R_{th(j-mb)}$	thermal resistance from junction to mounting base		-	-	1.02	K/W

C_{th1}	4.600E-05 F
C_{th2}	3.048E-04 F
C_{th3}	3.403E-04 F
C_{th4}	2.544E-03 F
C_{th5}	4.385E-03 F
C_{th6}	1.298E-02 F
C_{th7}	1.537E-01 F
R_{th1}	1.861E-03 Ω
R_{th2}	3.756E-03 Ω
R_{th3}	2.584E-02 Ω
R_{th4}	4.203E-02 Ω
R_{th5}	2.149E-01 Ω
R_{th6}	6.556E-01 Ω
R_{th7}	7.773E-02 Ω

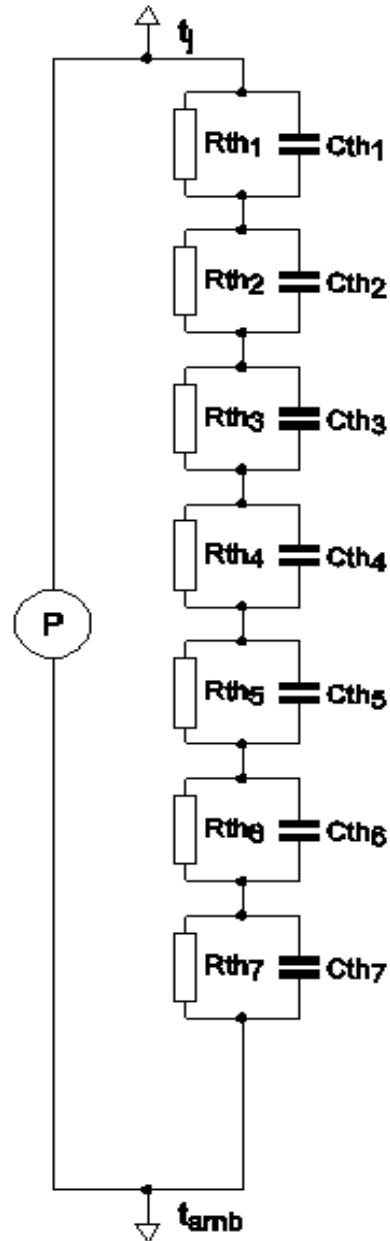

Part: BUK7Y22-100E
 Date: 25/1/2013
 Rth 1.02 K/W